

S.NO	CATALOG NUMBER	L	N
1	NNM500-3	7.06 [179]	3
2	NNM500-3I	7.06 [179]	3
3	NNM500-4	8.25 [210]	4
4	NNM500-4I	8.25 [210]	4
5	NNM500-6	10.63 [270]	6
6	NNM500-6I	10.63 [270]	6
7	NNM500-8	13.10 [330]	8
8	NNM500-8I	13.10 [330]	8

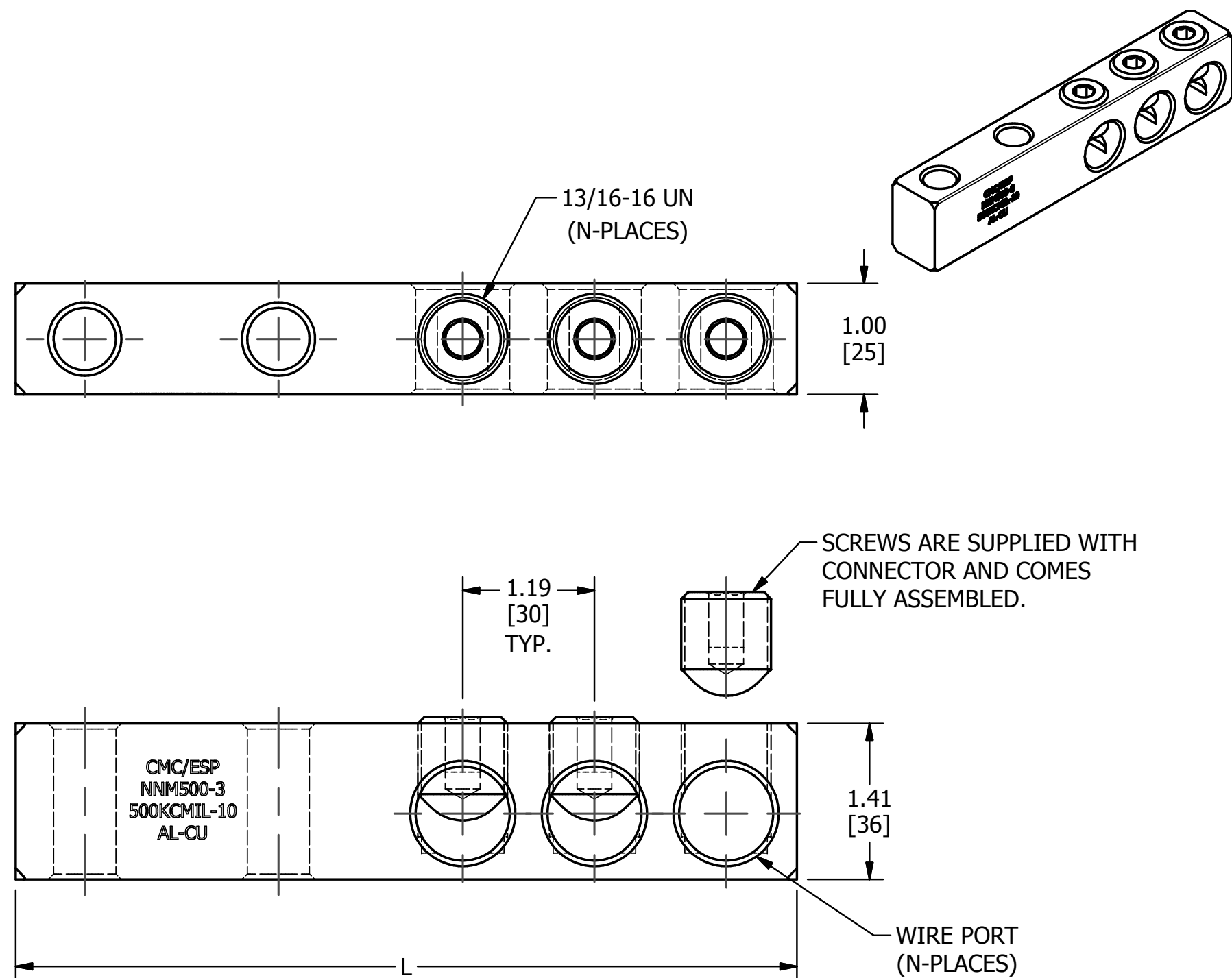

FINISH: CLEAR PLATE
MATERIAL: ALUMINUM

					TO ORDER CMC PRODUCTS CALL 1-513-860-4455	DRAWN BY: TS 09-25-19	NAME OF PART: NEMA MOUNT CONNECTOR ASSEMBLY	CAT. NO.: SEE TABLE
					FOR PRODUCT INFO: http://www.cmclugs.com	CHECKED BY:	DWG NO: C58700250-S (CHARTED)	A
A	NEW DRAWING CREATED		09-25-19	TS		DRAWING NOT TO SCALE		SHEET NO: 1 OF 1
REV.	DESCRIPTION	ECN	DATE	INIT.				

THIS INFORMATION IS PROPRIETARY TO CONNECTOR MFG. CO. AND IS NOT TO BE DISCLOSED OUTSIDE OF CONNECTOR MFG. CO. WITHOUT A CONFIDENTIALITY AGREEMENT



CONNECTOR MANUFACTURING CO.

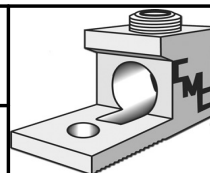

HAMILTON, OHIO